

Référence kit complet : 247155000

Référence	Désignation	Qté
244479000	Bague clipse Ø25	6
244484000	Coude 90° pour tuyau Ø25 int	2
244480000	Ecrou	6
718005001	Ecrou tournant 1"	4
230689000	Joint torique 20.29 x 2.62	6
705002016	Joint torique 24,2 x 3	10
718007002	Mamelon 1"	2
244723000	Pentajet droit ARAG Ø25	2
244722000	Pentajet gauche ARAG Ø25	2
718013003	Raccord 1"1/2	2
718011002	Raccord coudé tournant 1» Ø25	2
237747000	Raccord droit femelle Ø30	2
237691000	Raccord droit mâle 1"1/2 Ø40	1
718013001	Raccord droit mâle 1"1/4 Ø25	2
718013002	Raccord droit mâle G1" Ø25	2
244486000	Raccord droit pour tuyau Ø25	2
244482000	Té pour tube Ø25	2
238788000	Té 1"1/2	1
244481000	Union mâle mâle M35	3
534003001	Vanne à bille 1"	1
244488000	Vanne manuelle 1"1/2 Ø40	1



	Kit raccord eau /	05.06.2012
	Water connection kit	Chap. 10
	247155000	P. 1

Référence kit complet : 247154000

Référence	Désignation	Qté
238511000	Té centre orientable Ø4	5
238305000	Coude mâle 90° orientable Ø4	5
238318000	Té pneumatique Ø8	2
047296000	Raccord égal en té Ø6	3
238320000	Raccord	2
238319000	Réducteur pneumatique Ø6/Ø4	2
238309000	Té centre orientable Ø4	3
240799000	Coude mâle 90° orientable Ø4	3
238803000	Raccord coudé à 90° Ø8 1/4»	2
047297000	Raccord coudé à 90° Ø6 1/4»	3
238178000	Electrovanne pneumatique	2
518015002	Té 4/6/4	5
238304000	Tuyau pneumatique Ø 2/4	3
238306000	Tuyau pneumatique Ø 4/6	3
238308000	Tuyau pneumatique Ø 6/8	3

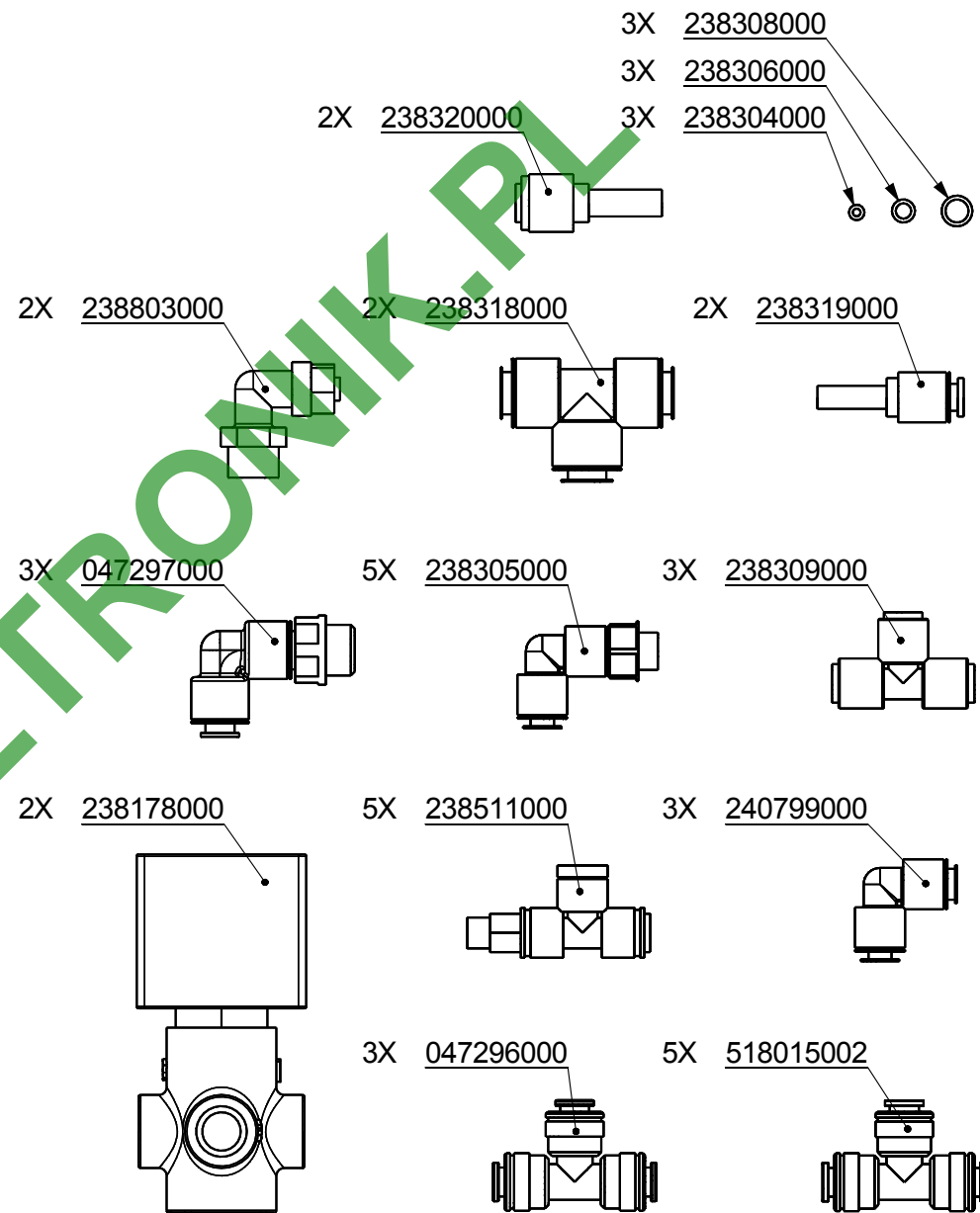

WWW.ROLTRONIK.PL

Xénon Pentajet 	Kit raccord air / Pneumatic connection kit	23.06.2014
	247154000	Chap. 10 P. 2

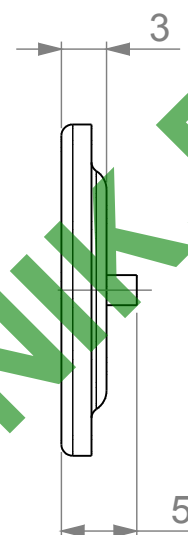
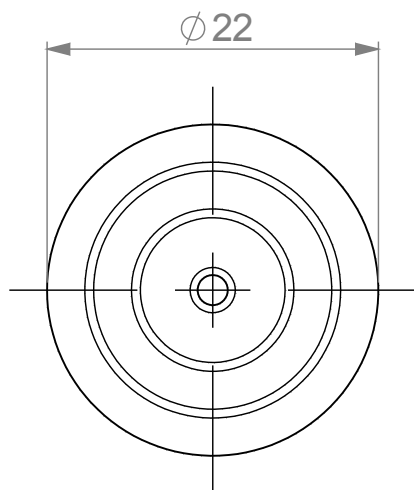

Porte jet		Membrane
Pentajet Arag Ø25	244722000	534021002
Pentajet Arag Ø25	244723000	534021002
Pentajet Arag Ø20	247318000	534021002
Pentajet Arag Ø20	247319000	534021002

WWW.POLTRONIK.PL

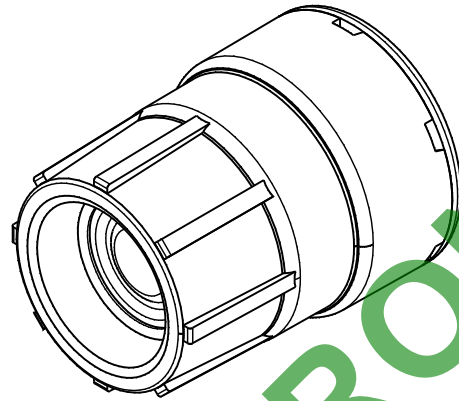

Porte jet		Soupape
Pentajet Arag Ø25	244722000	534021003
Pentajet Arag Ø25	244723000	534021003
Pentajet Arag Ø20	247318000	534021003
Pentajet Arag Ø20	247319000	534021003

WWW.POLTRONIK.PL

Xénon Expert	Soupape / Valve	30.09.2013
Mathot		Chap. 10
		P. 4

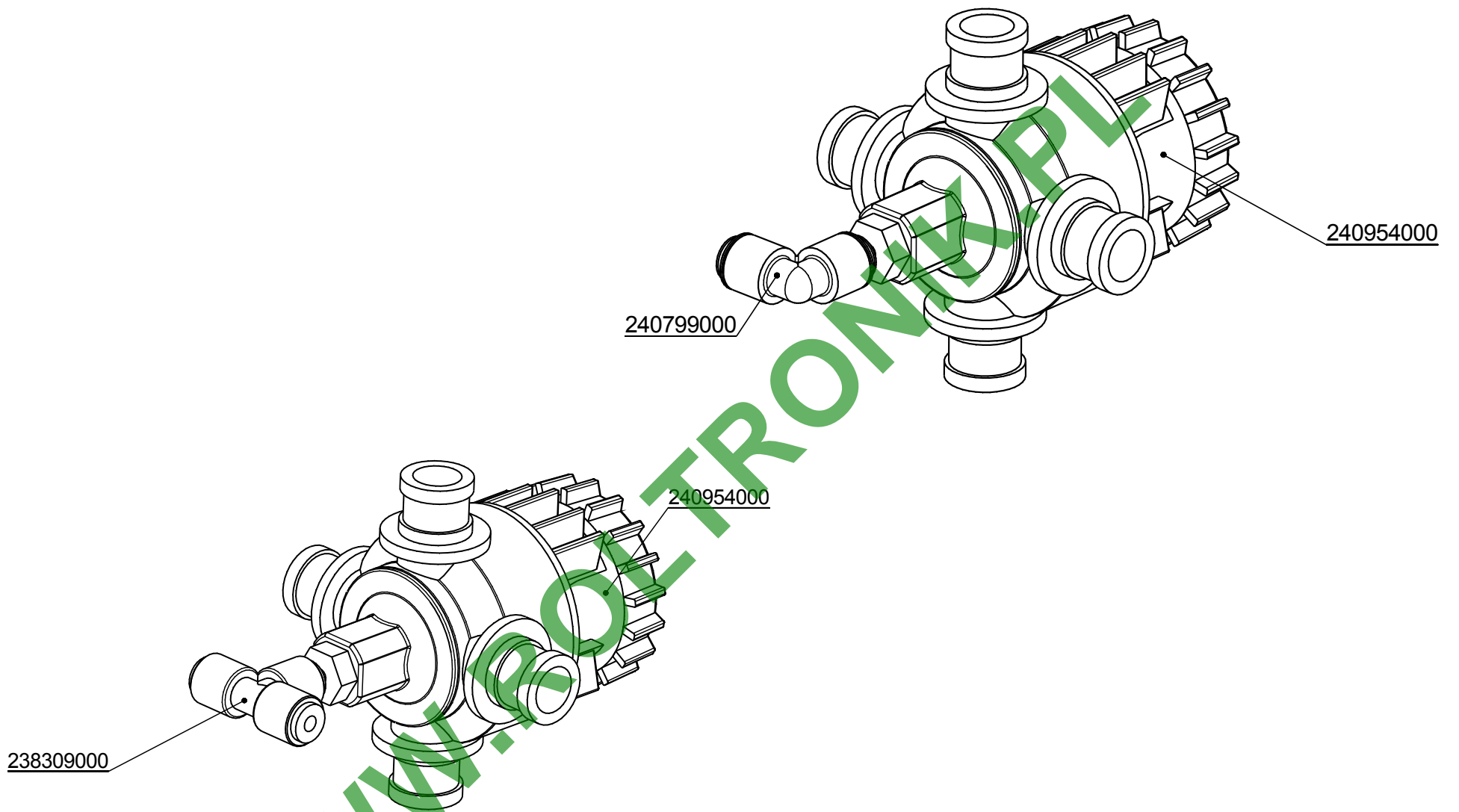

WWW.ROULETRONLINE.FR

Xénon Pro	Quadrijet	11.01.2010
Mathot		Chap. 10
		P. 5

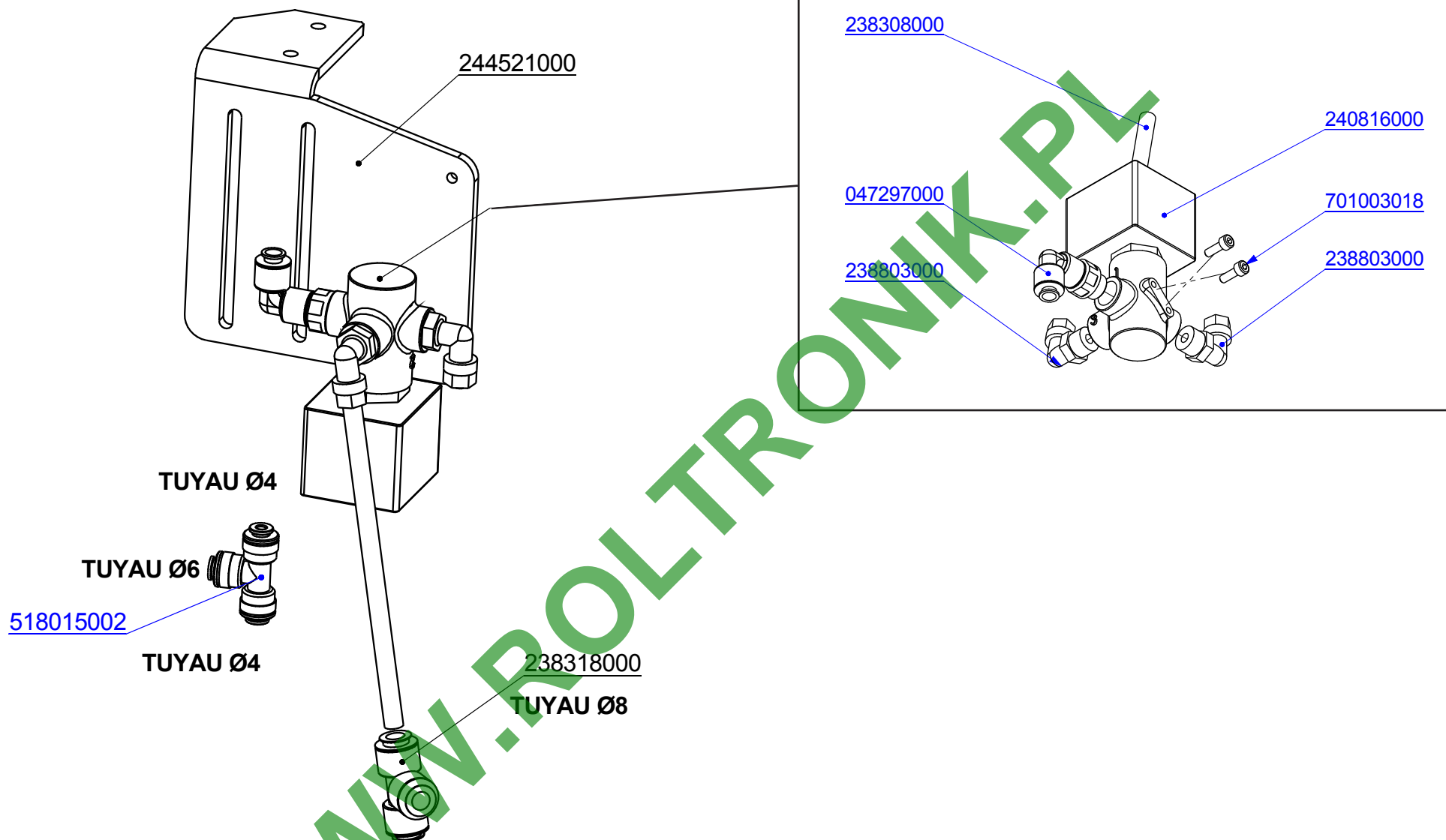

KIT BLOC ELECTROVANNE pour tronçonnage rampe PPI

Xénon Pro	Electrovanne pour quadrijet	27.09.2010
Mathot		Chap. 10
	247691000	P. 6

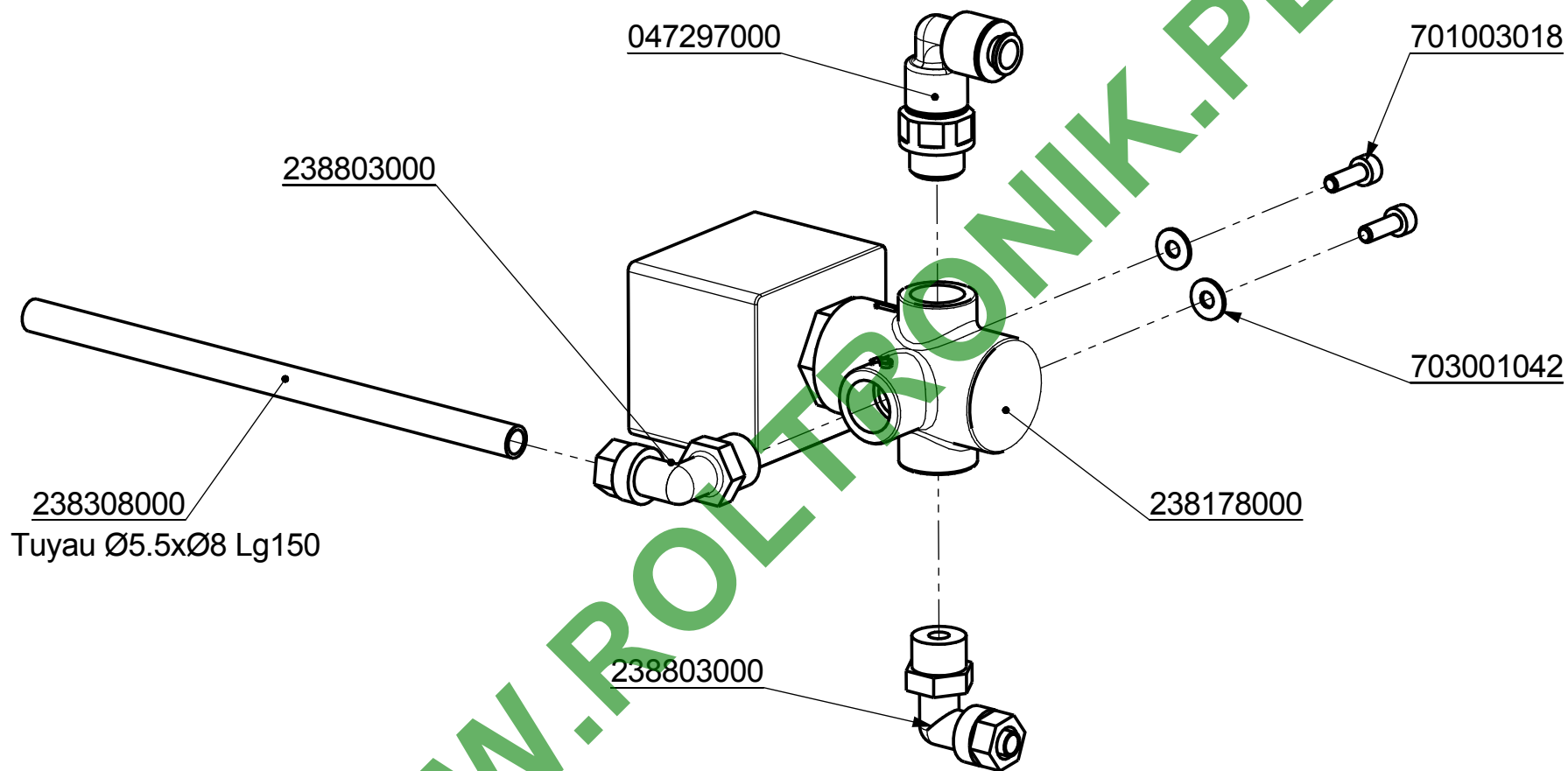

Xénon	Electrovanne équipée pour Pentajet	11.09.2012
Mathot	247178000	Chap. 10
		P. 7

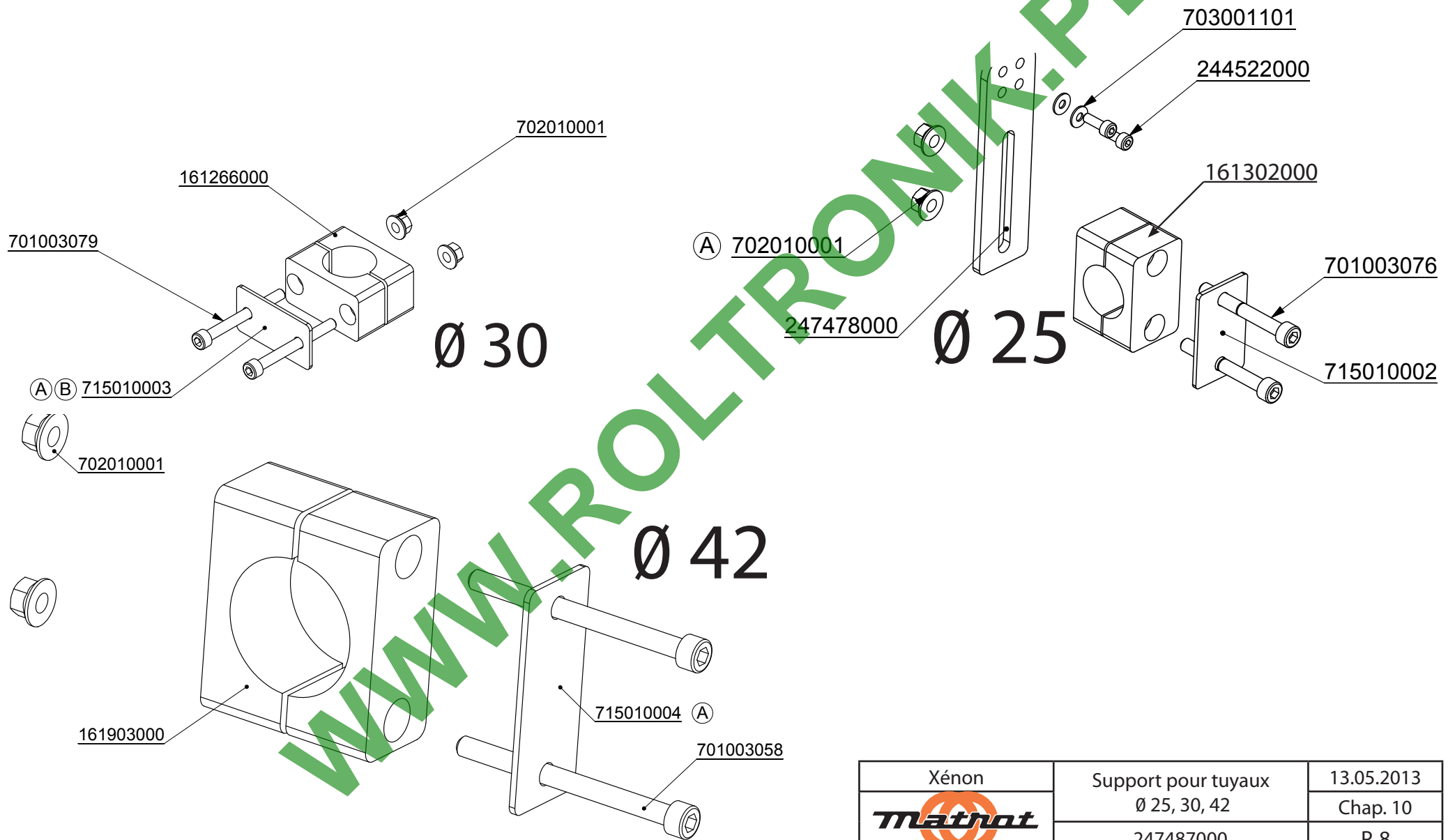

Xénon	Support pour tuyaux Ø 25, 30, 42	13.05.2013
Mathot	247487000	Chap. 10
		P. 8

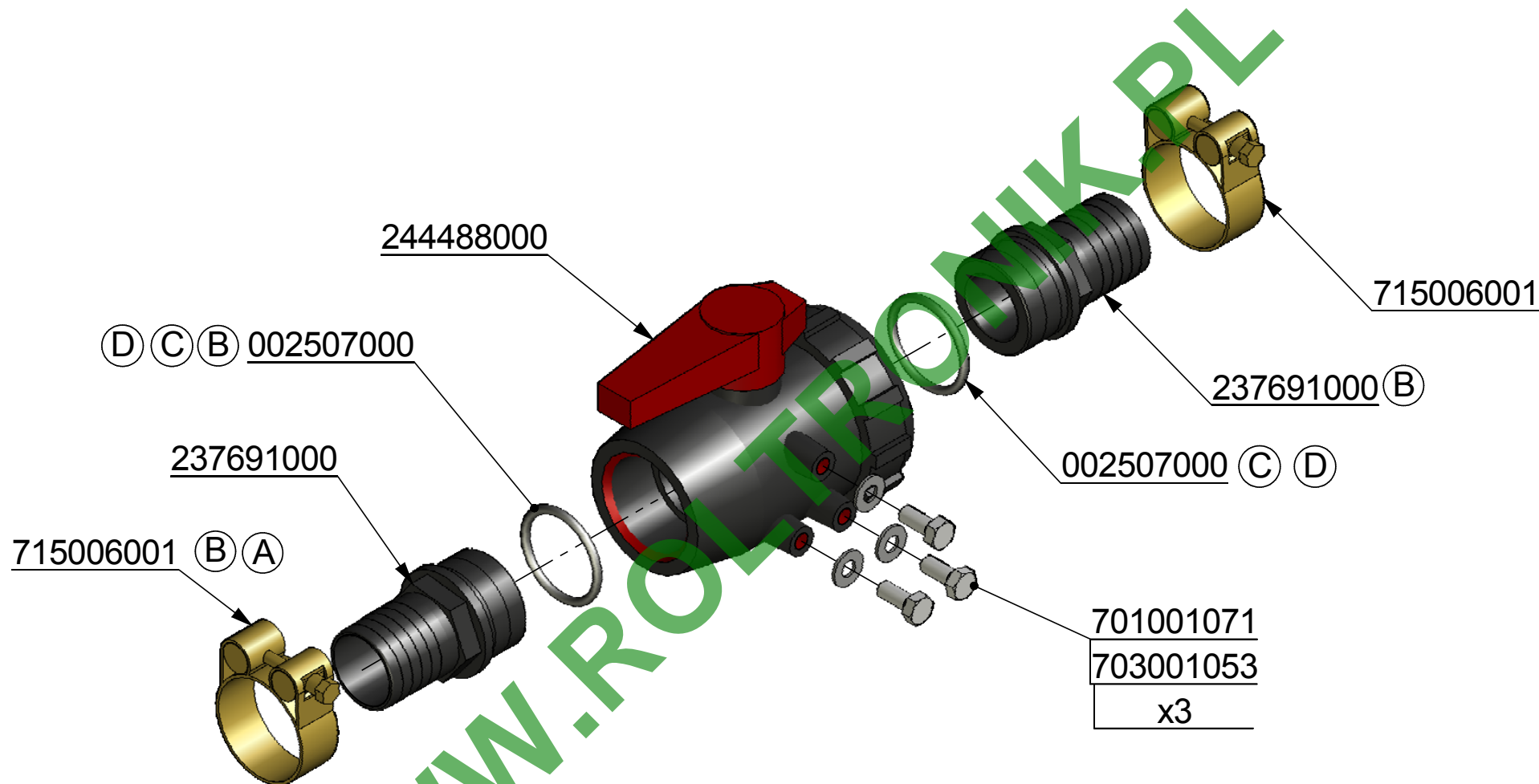

WWW.ROTHORONLINE.PL

Xénon	Vanne manuelle / Manual valve	28.08.2013
Mathot		Chap. 10
	244809000	P. 9

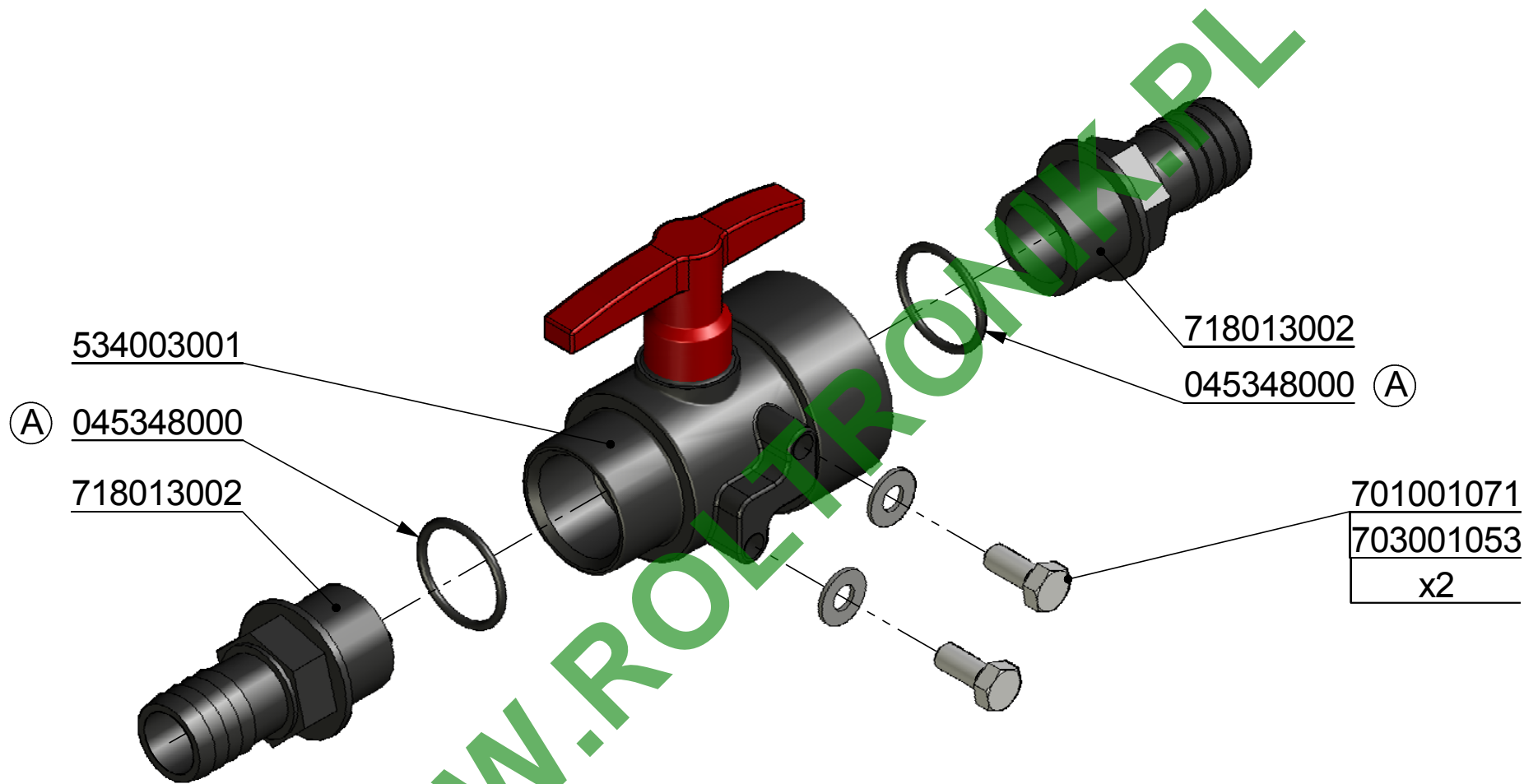

WWW.ROLLERWORKS.PL

Xénon	Vanne manuelle Ø25/ Manual valve Ø25	12.06.2013
Mathot		Chap. 10
	244808000	P. 10

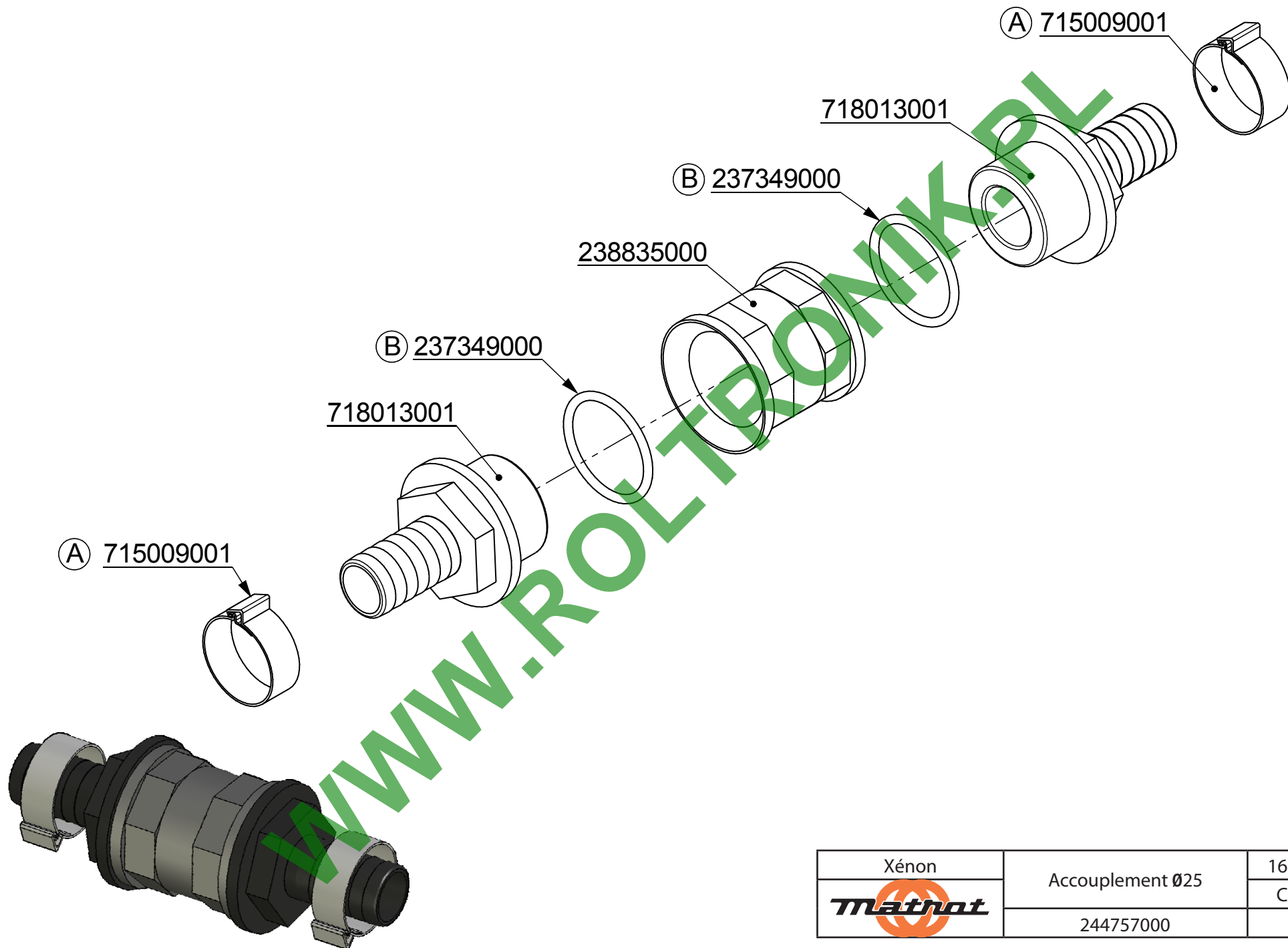

Xénon	Accouplement Ø25	16.06.2013
Mathot		Chap. 10
	244757000	P. 11

POUR TUYAU Ø30

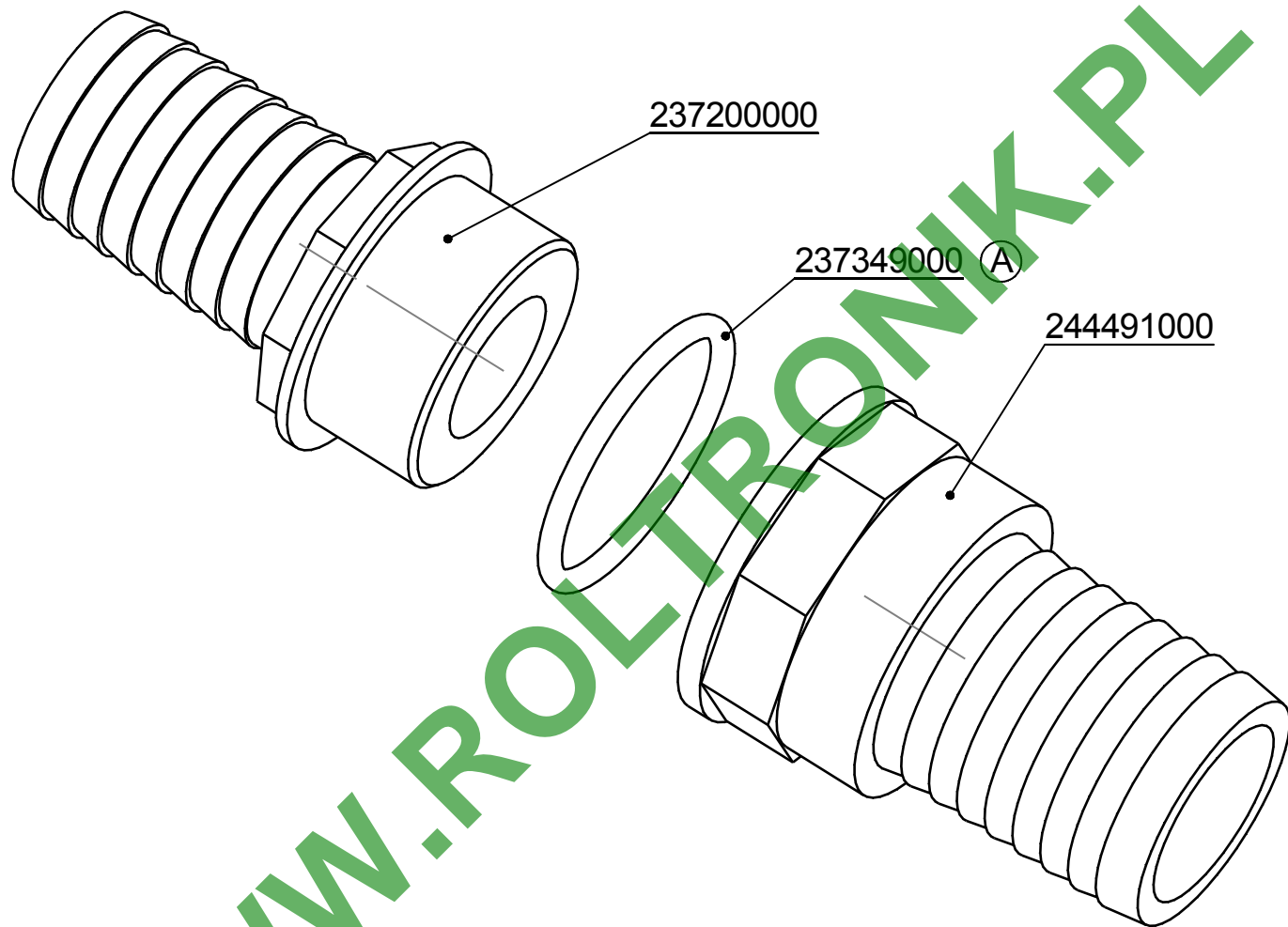

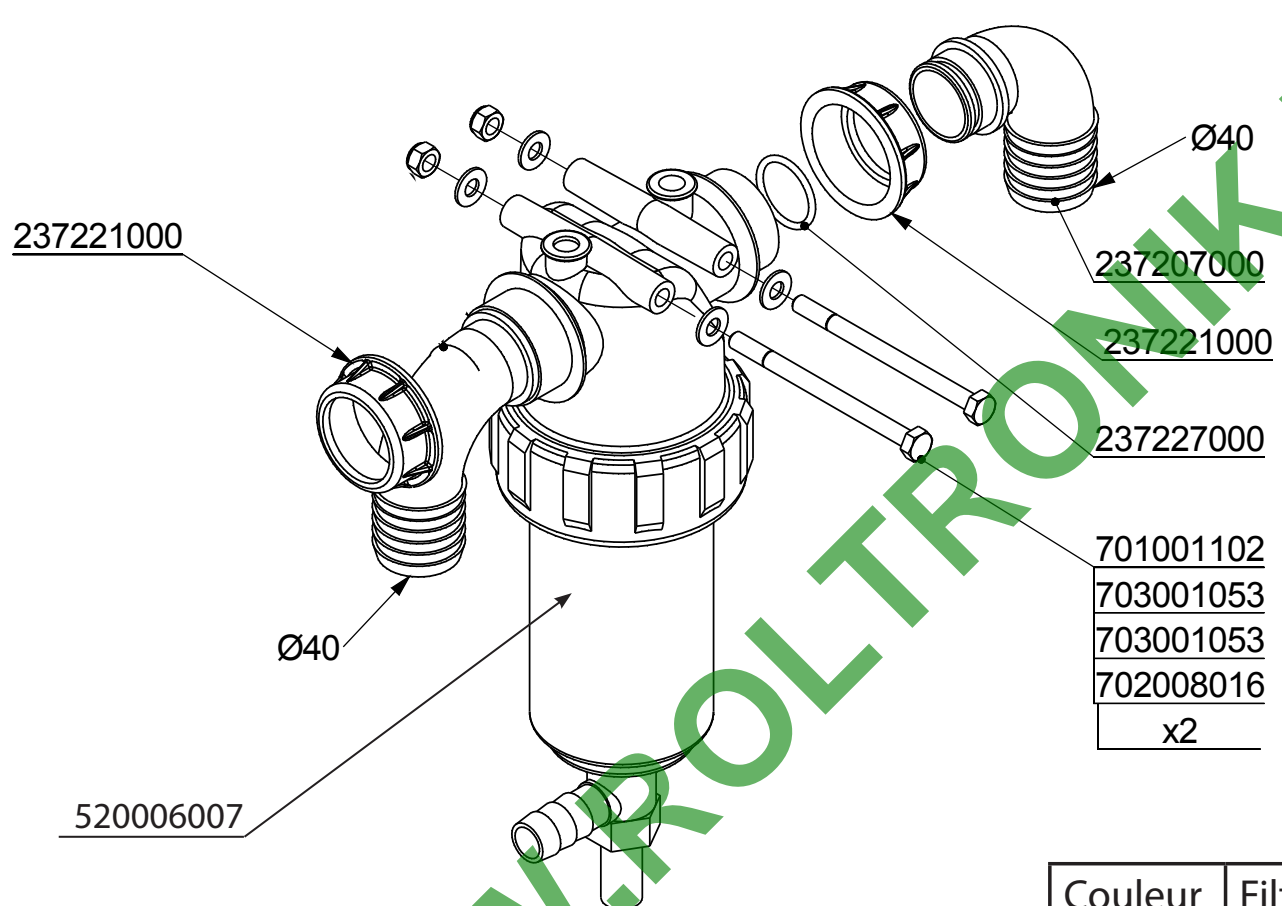

POUR TUYAU Ø40

Xénon	Réduction Ø40 / Ø30	17.06.2013
	244955000	Chap. 10
		P. 12



WWW.POLTRONIK.PL

Couleur	Filtration	Ref
	50 Mesh	237335000
	80 Mesh	520006013
	100 Mesh	238698000

Xénon	Filtre de rampe / Boom filter	05.06.2012
	244811000	Chap. 10
		P. 13

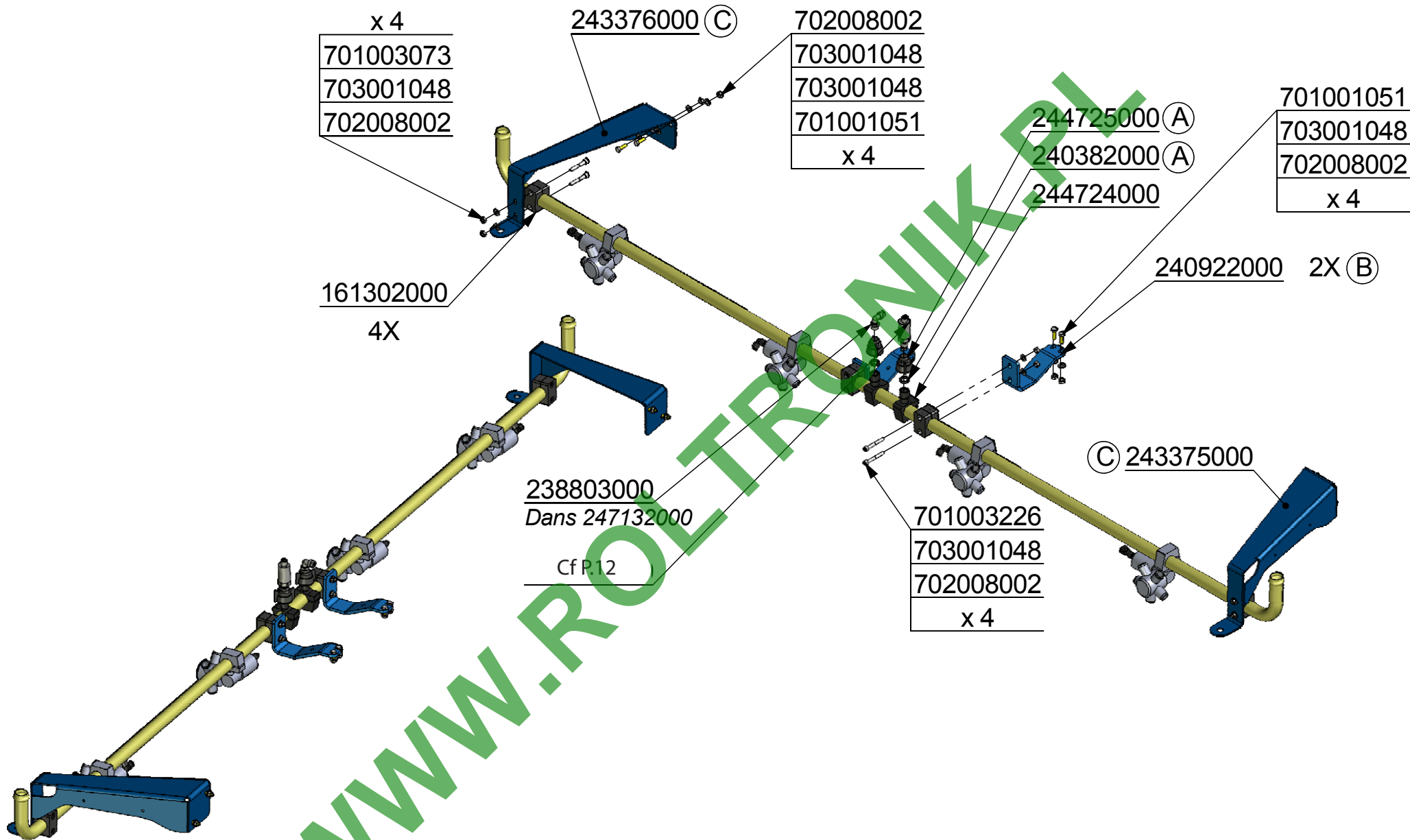

WWW.ROLIFRONIK.COM

Xénon	Pulvérisation cadre central	08.11.2013
		Chap. 10
	247313000	P. 14

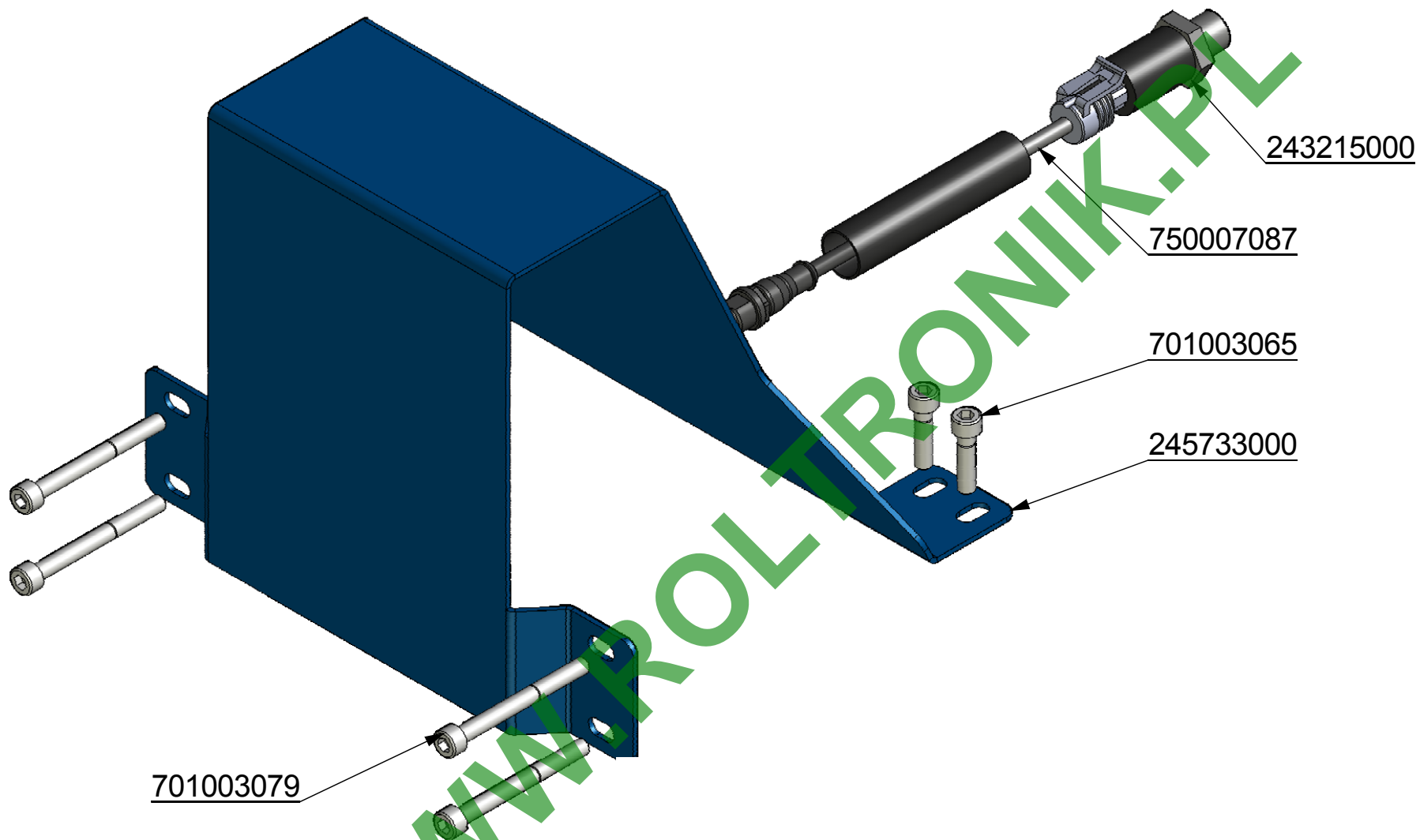

Xénon	Kit capteur pression	17.03.2014
Mathot		Chap. 10
	243670000	P. 15

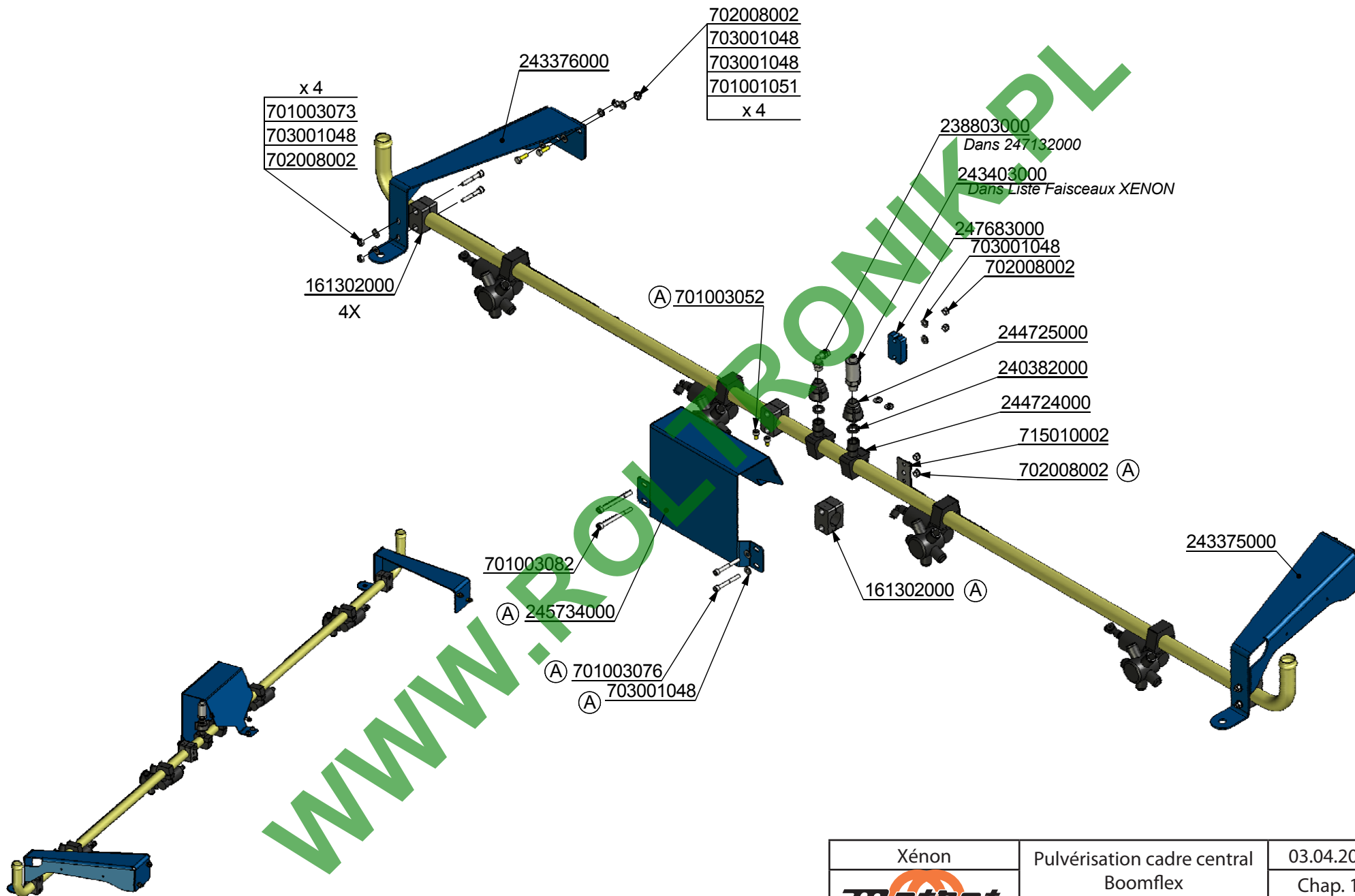

WWW.ROLBOONIK.PL

Xénon	Pulvérisation cadre central	03.04.2014
	Boomflex	Chap. 10
	247682000	P. 16

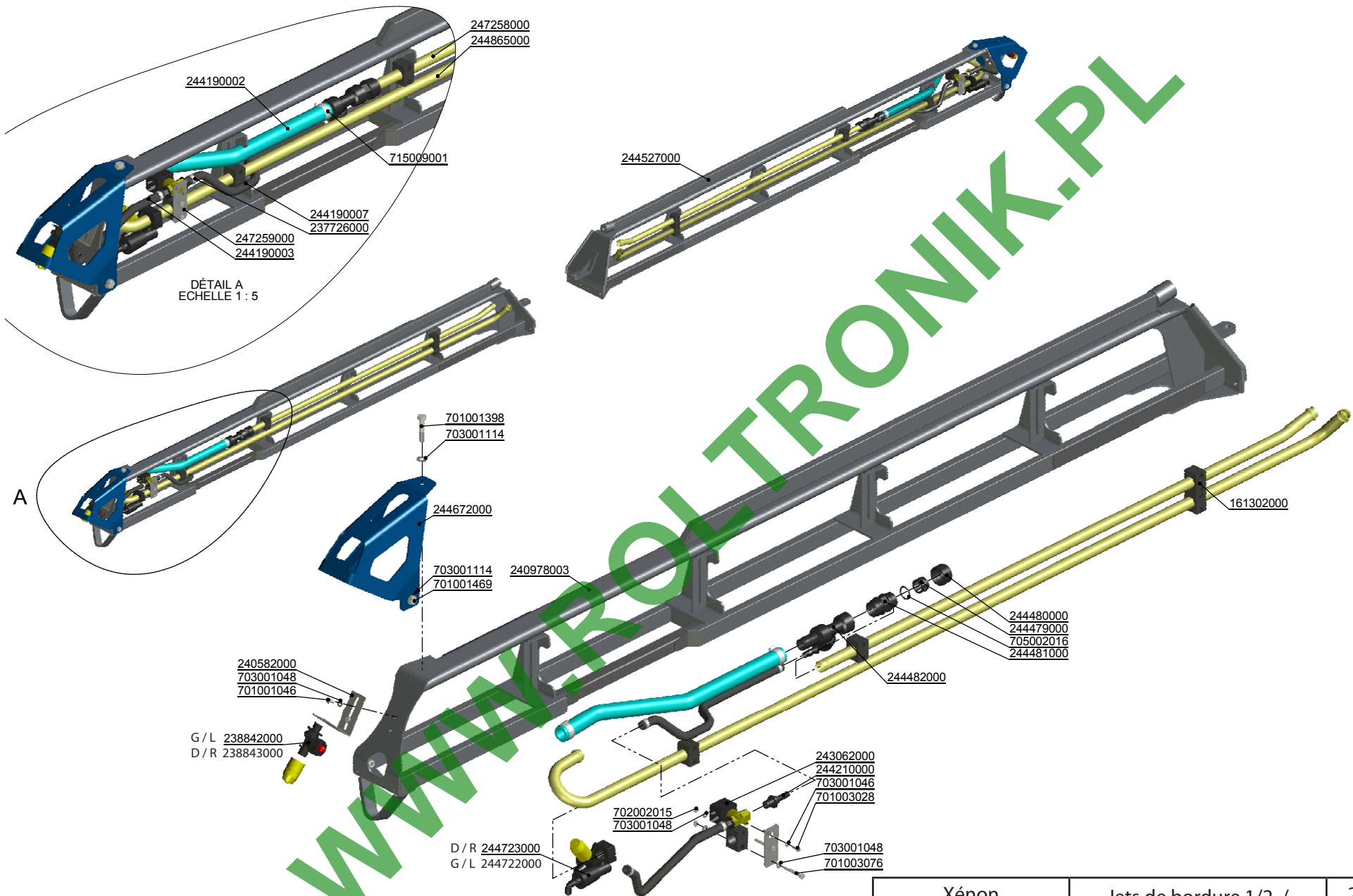

Xénon 	Jets de bordure 1/2 / Hedge nozzles 1/2	20.12.2011 Chap. 10
	244190000	P. 17

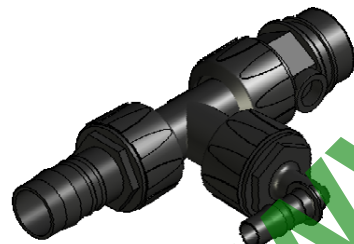
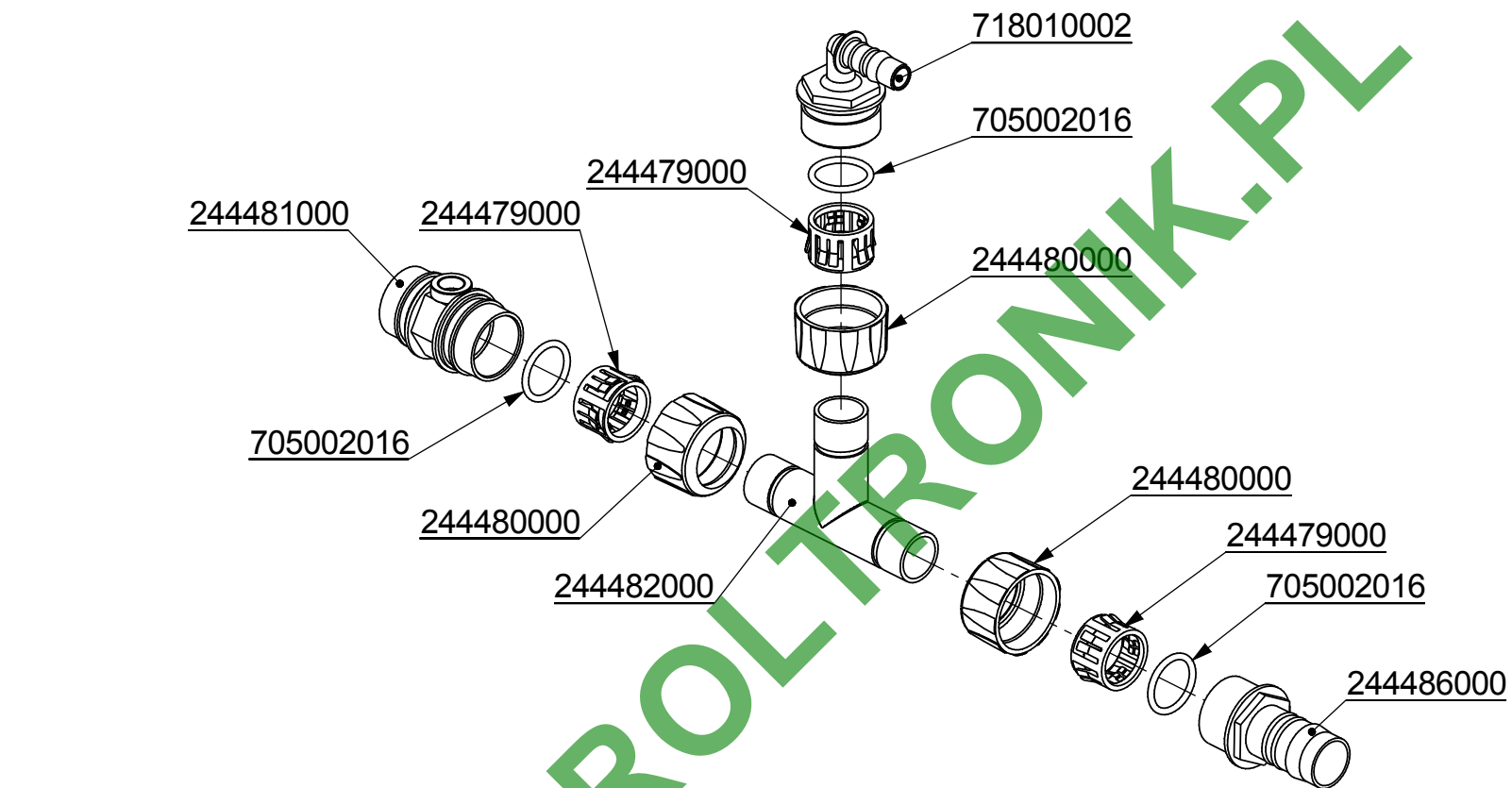

Xénon	Jets de bordure 2/2 / Hedge nozzles 2/2	15.12.2011
Mathot	247250000	Chap. 10
		P. 18

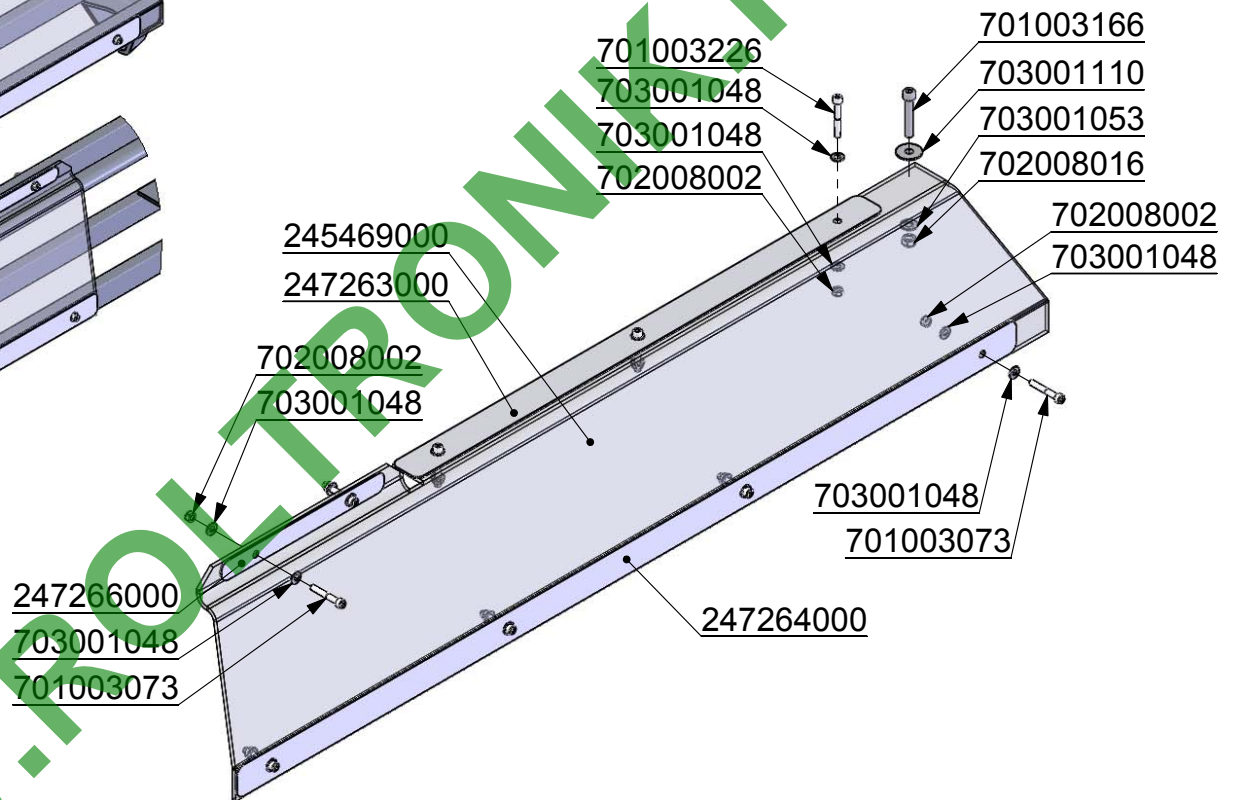
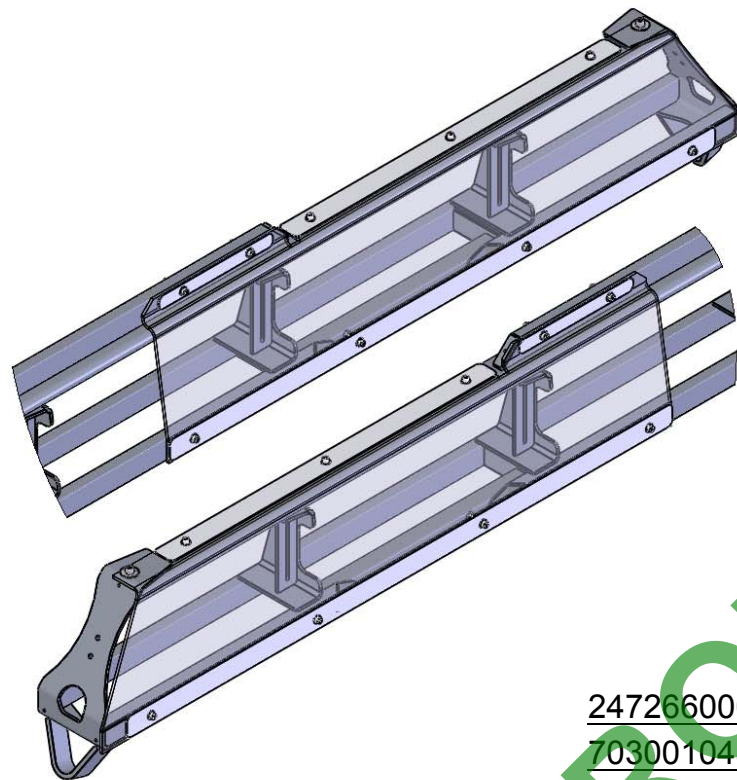

WWW.POLYRONLINE.PL

Xénon	Bache bras de sécurité / Canvas sheet for security arm	18.01.2012
Mathot		Chap. 10
	247265000	P. 19

WWW.ROLTRONIK.PL

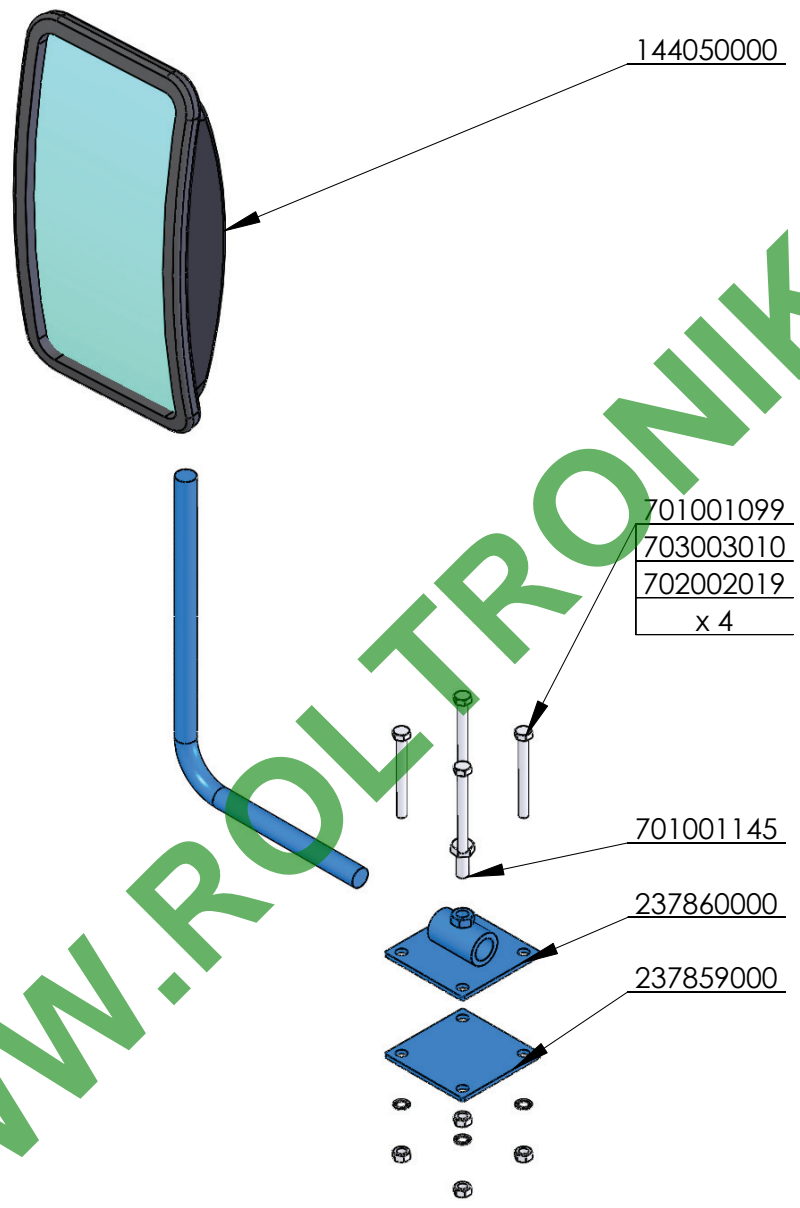

Xénon	Rétroiseur	13.04.2012
		Chap. 10
	247299000	P. 20

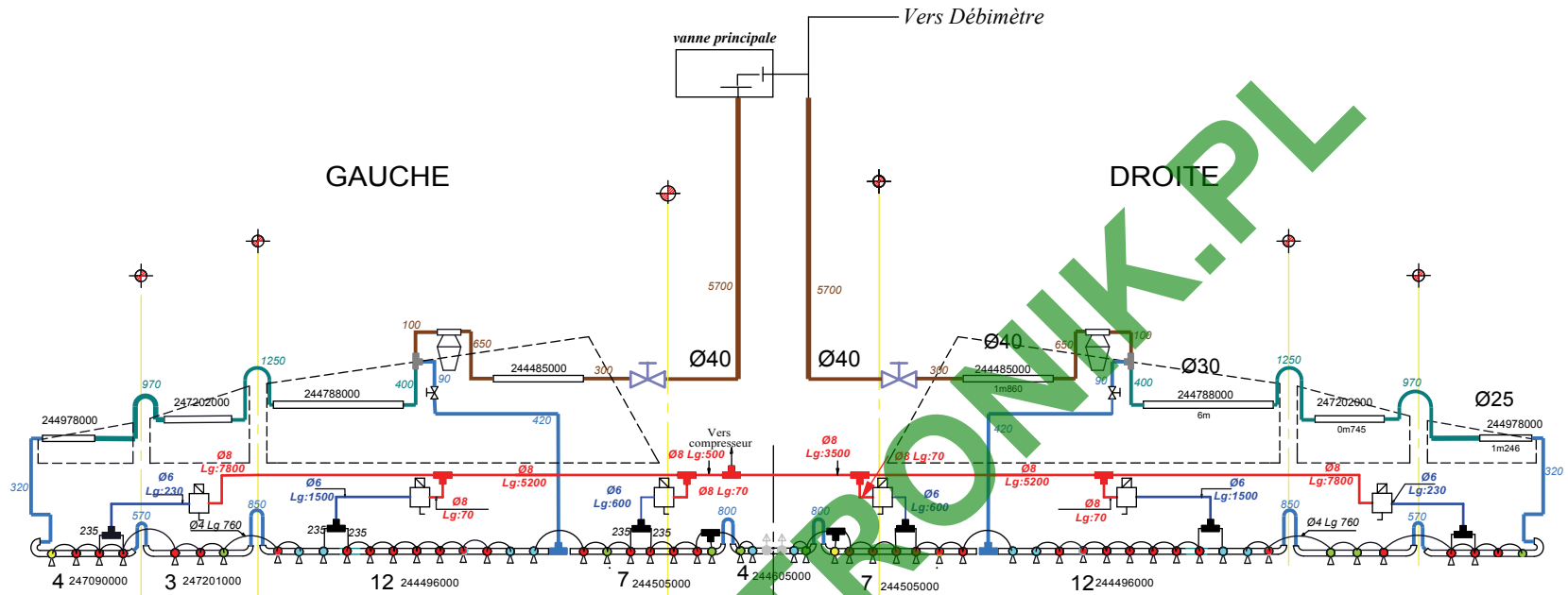



 → 244 725 000 Raccord 1/4"NPT capteur/mano
 + 244 724 000 porte buse Ø25 capteur/mano

 → 244809000 Vanne manuelle équipé Ø40 (A)

 → 244 745 Pentajet équipé PNEUMATIQUE Ø25 Gauche

 → 244 746 Pentajet équipé PNEUMATIQUE Ø25 Gauche

 → 244 747 Pentajet équipé PNEUMATIQUE Ø25 Droit

 → 244 748 Pentajet équipé PNEUMATIQUE Ø25 Droit

 → 244808000 Vanne manuelle équipée Ø25 (A)

 → 244811000 Filtre équipé Ø40

 → 238318000 Té pneumatique Ø8









 → 518015002 Raccord égal en Té Ø4-Ø6-Ø4 (A)

 → 244522000 Electrovanne pneumatique équipé

 → 244602000 Té équipé retour filtre

 → 244790000 Té équipé sortie filtre

 → 244694000 Té équipé pour prise de pression

-  Tuyau d'alimentation Ø40
-  Tuyau d'alimentation Ø30
-  Tuyau d'alimentation Ø25
-  Tuyau inox 304L Ø25
-  Tuyau inox 304L Ø40
-  Tuyau inox 304L Ø30
-  Tuyau pneumatique Ø4
-  Tuyau pneumatique Ø6
-  Tuyau pneumatique Ø8

Xénon Expert 	28m - 6T	05.06.2012
	9-9-10-10-9-9	Chap. 10
	247198000	P. 21

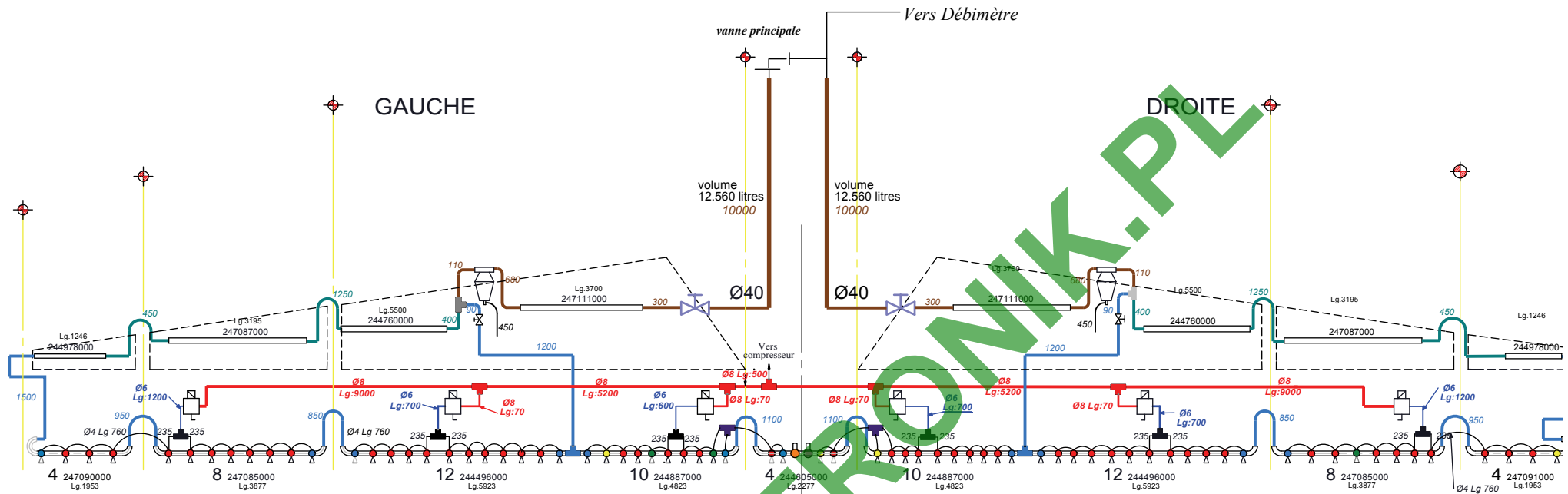







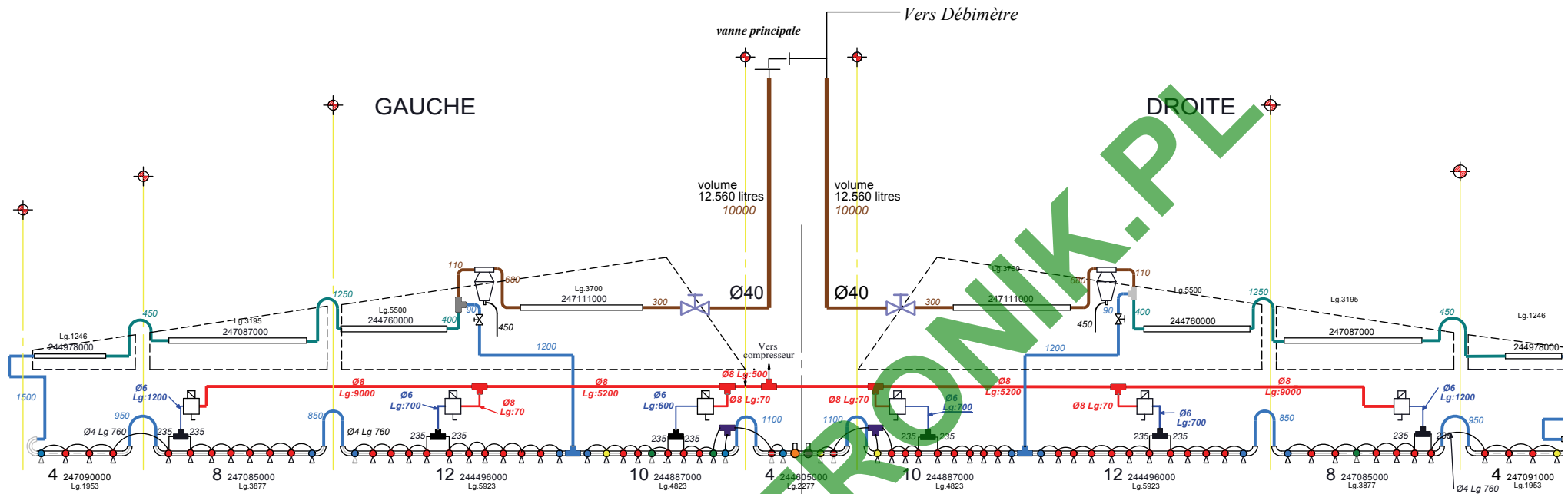









- 247042000 Porte raccord mano équipé
- 247043000 Porte capteur de pression équipé
- 244809000 Vanne manuelle Ø40 (A)
- 244745000 Pentajet équipé PNEUMATIQUE Ø25 Gauche
- 244746000 Pentajet équipé PNEUMATIQUE Ø25 Gauche
- 244747000 Pentajet équipé PNEUMATIQUE Ø25 Droit
- 244748000 Pentajet équipé PNEUMATIQUE Ø25 Droit
- 244842000 Vanne à bille G1" DN25 équipée
- 244811000 Filtre équipé
- 238309000 Té pneumatique Ø4
- 238318000 Té pneumatique Ø8
- 518015002 Raccord égal en Té Ø4-Ø6-Ø4 (A)
- 244522000 Electrovanne pneumatique équipé
- 244602000 Té équipé retour filtre
- 244790000 Té équipé sortie filtre

- Tuyau d'alimentation Ø40
- Tuyau d'alimentation Ø30
- Tuyau d'alimentation Ø25
- Tuyau d'alimentation Ø20
- Tuyau inox 304L Ø40
- Tuyau inox 304L Ø30
- Tuyau inox 304L Ø25
- Tuyau pneumatique Ø4
- Tuyau pneumatique Ø6
- Tuyau pneumatique Ø8

Xénon Expert	36m - 6T	05.06.2012
	12-12-12-12-12-12	Chap. 10
	247119000	P. 22





-  → 247042000 Porte raccord mano équipé
-  → 247043000 Porte capteur de pression équipé
-  → 244809000 Vanne manuelle Ø40 (A)
-  → 244745000 Pentajet équipé PNEUMATIQUE Ø25 Gauche
-  → 244746000 Pentajet équipé PNEUMATIQUE Ø25 Gauche
-  → 244747000 Pentajet équipé PNEUMATIQUE Ø25 Droit
-  → 244748000 Pentajet équipé PNEUMATIQUE Ø25 Droit
-  → 244842000 Vanne à bille G1" DN25 équipée
-  → 244811000 Filtre équipé
-  → 238309000 Té pneumatique Ø4
-  → 238318000 Té pneumatique Ø8
-  → 518015002 Raccord égal en Té Ø4-Ø6-Ø4 (A)
-  → 244522000 Electrovanne pneumatique équipé
-  → 244602000 Té équipé retour filtre
-  → 244790000 Té équipé sortie filtre

-  Tuyau d'alimentation Ø40
-  Tuyau d'alimentation Ø30
-  Tuyau d'alimentation Ø25
-  Tuyau d'alimentation Ø20
-  Tuyau inox 304L Ø40
-  Tuyau inox 304L Ø30
-  Tuyau inox 304L Ø25
-  Tuyau pneumatique Ø4
-  Tuyau pneumatique Ø6
-  Tuyau pneumatique Ø8

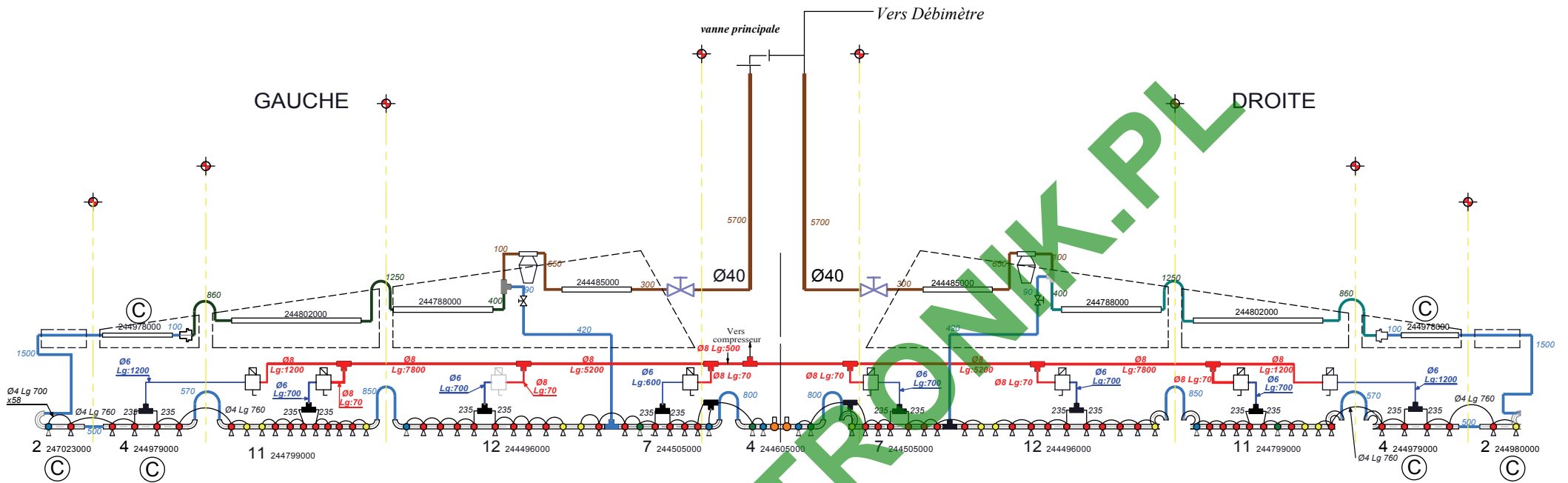
Xénon Expert	38-36m - 6T	05.06.2012
	12-12-12-12-12-12	Chap. 10
	247119000	P. 23





 → 244 725 000 Raccord 1/4"NPT capteur/mano
 + 244 724 000 porte buse Ø25 capteur/mano

 → 244809000 Vanne manuelle Ø40

 → 244812000 Reduction Ø25 - Ø30

 → 244 745 Pentajet équipé PNEUMATIQUE Ø25 Gauche

 → 244 746 Pentajet équipé PNEUMATIQUE Ø25 Gauche

 → 244 747 Pentajet équipé PNEUMATIQUE Ø25 Droit

 → 244 748 Pentajet équipé PNEUMATIQUE Ø25 Droit

 → 244842000 Vanne manuelle Ø25 équipé

 → 244811000 Filtre équipé









 → 238318000 Té pneumatique Ø8

 → 240277000 Té pneumatique Ø6

 → 244522000 Electrovanne pneumatique équipé

 → 244602000 Té équipé retour filtre

 → 244790000 Té équipé sortie filtre





-  Tuyau d'alimentation Ø40
-  Tuyau d'alimentation Ø30
-  Tuyau d'alimentation Ø25
-  Tuyau inox 304L Ø40
-  Tuyau inox 304L Ø30
-  Tuyau inox 304L Ø25
-  Tuyau pneumatique Ø4
-  Tuyau pneumatique Ø6
-  Tuyau pneumatique Ø8



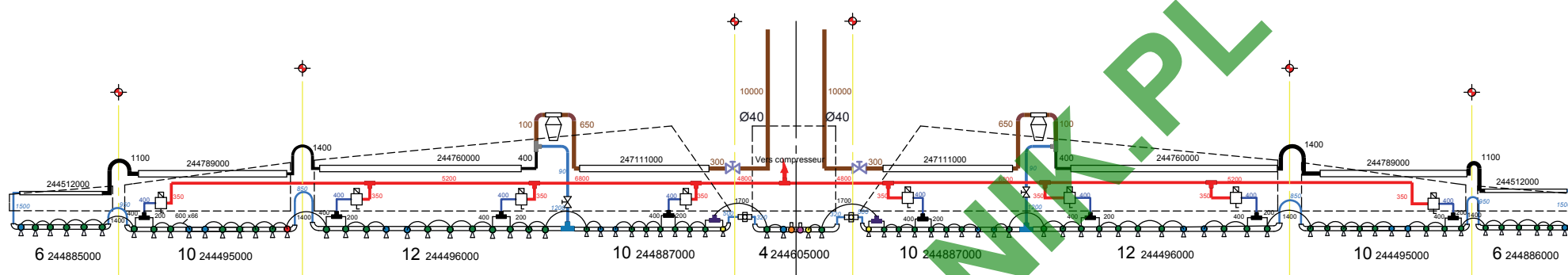







Xénon Expert	38-36m - 8T	11.03.2011
	8-9-10-11-11-10-9-8	Chap. 10
	244792000	P. 24









GAUCHE

DROITE

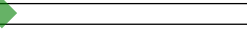

-  244811000 Filtre équipé Ø40
-  244602000 Té équipé raccord Hardi
-  244757000 Accouplement Ø25 (A)
-  244842000 Vanne manuelle DN25 équipée
-  244809000 Vanne manuelle équipée Ø40 (A)

-  244790000 Té Ø40-Ø30
-  244522000 Electrovanne pneumatique équipé
-  238309000 Té pneumatique Ø4
-  518015002 Raccord égal en Té Ø4-Ø6-Ø4 (A)
-  238318000 Té pneumatique Ø8
-  247042000 Porte raccord mano équipé
-  247043000 Porte capteur pression équipé
-  244747000 Pentajet ARAG Ø25 Droit équipé d'un Té
-  244748000 Pentajet ARAG Ø25 Droit équipé d'un Coude
-  244745000 Pentajet ARAG Ø25 Gauche équipé d'un Té
-  244746000 Pentajet ARAG Ø25 Gauche équipé d'un Coude





-  Tube Inox Ø25
-  Tube Inox Ø30
-  Tube Inox Ø40
-  Tuyau Ø40
-  Tuyau Ø30
-  Tuyau Ø25
-  Tuyau pneumatique Ø4
-  Tuyau pneumatique Ø6
-  Tuyau pneumatique Ø8



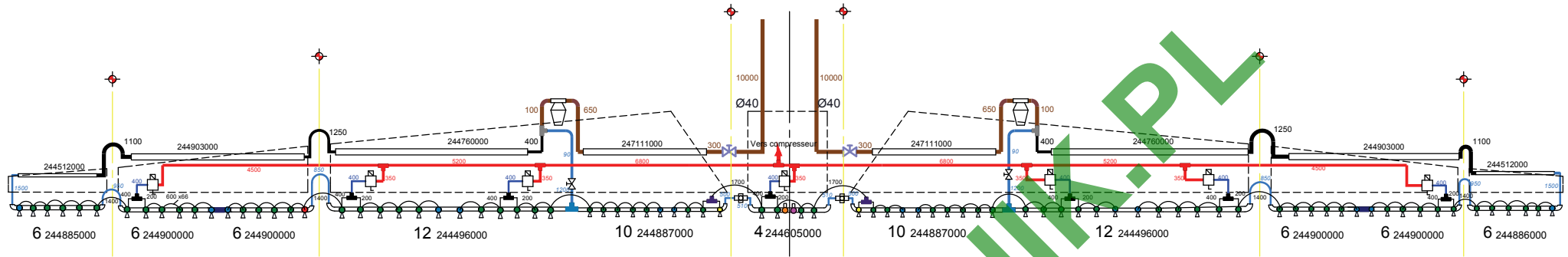









Xénon Expert	40m - 8T	11.03.2011
	10-10-10-10-10-10-10	Chap. 10
	247122000	P. 25









GAUCHE

DROITE



-  244811000 Filtre équipé Ø40
-  244602000 Té équipé
-  244757000 Accouplement Ø25 (A)
-  244842000 Vanne manuelle DN25 équipée
-  244809000 Vanne manuelle équipée Ø40 (A)

-  244790000 Té Ø40-Ø30
-  244522000 Electrovanne pneumatique équipé
-  238309000 Té pneumatique Ø4
-  518015002 Raccord égal en Té Ø4-Ø6-Ø4 (A)
-  238318000 Té pneumatique Ø8
-  247042000 Porte raccord mano équipé
-  247043000 Porte capteur pression équipé
-  244747000 Pentajet ARAG Ø25 Droit équipé d'un Té
-  244748000 Pentajet ARAG Ø25 Droit équipé d'un Coude
-  244745000 Pentajet ARAG Ø25 Gauche équipé d'un Té
-  244746000 Pentajet ARAG Ø25 Gauche équipé d'un Coude
-  244779000 Union Ø25

-  Tube Inox Ø25 €
-  Tube Inox Ø30
-  Tube Inox Ø40
-  Tuyau Ø40
-  Tuyau Ø30
-  Tuyau Ø25
-  Tuyau pneumatique Ø4
-  Tuyau pneumatique Ø6
-  Tuyau pneumatique Ø8

Xénon Expert	42m - 7T	11.03.2011
	12-12-12-12-12-12-12	Chap. 10
	247125000	P. 26

GAUCHE

DROITE

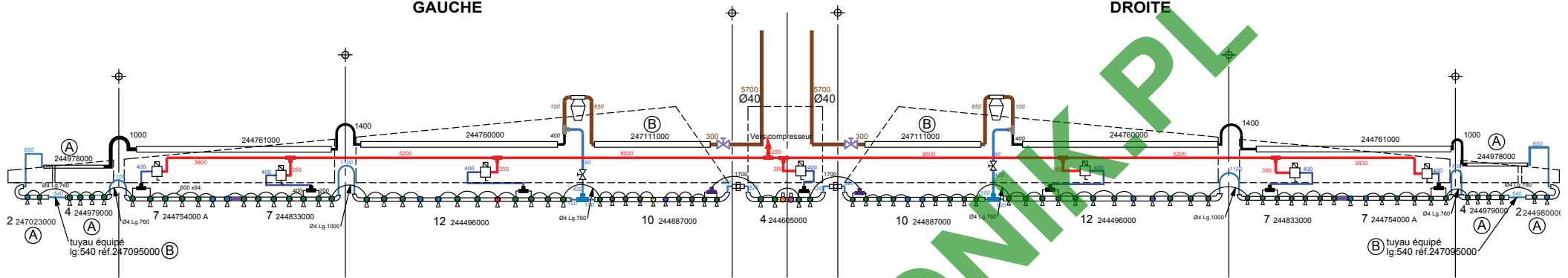



 247095000 Tuyau équipé **Attention orientation**

 244811000 Filtre équipé Ø40 (B)

 244602000 Té équipé

 244757000 Accouplement Ø25 (C)

 244842000 Vanne manuelle DN25 équipée

 244809000 Vanne manuelle équipée Ø40 (B) (C)

 244790000 Té Ø40-Ø30 (B)

 244522000 Electrovanne pneumatique équipé

 238309000 Té pneumatique Ø4 (B)

 518015002 Raccord égal en Té Ø4-Ø6-Ø4 (C)

 238318000 Té pneumatique Ø8

 247043000 Porte capteur pression équipé

 247042000 Porte raccord mano équipé

 244747000 Pentajet ARAG Ø25 Droit équipé d'un Té

 244748000 Pentajet ARAG Ø25 Droit équipé d'un Coude

 244745000 Pentajet ARAG Ø25 gauche équipé d'un Té

 244746000 Pentajet ARAG Ø25 gauche équipé d'un Coude

 244779000 Union Ø25

 Tube Inox Ø25

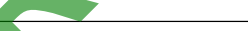
 Tube Inox Ø30

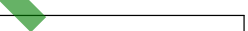
 Tube Inox Ø40

 Tuyau Ø40

 Tuyau Ø30

 Tuyau Ø25

 Tuyau pneumatique Ø4

 Tuyau pneumatique Ø6

 Tuyau pneumatique Ø8

Xénon Expert	38-36m - 8T	11.03.2011
	12-12-12-12-12-12	Chap. 10
	244792000	P. 27